

GEOMETRIE TELAI CORSA ROAD FRAMES GEOMETRIES

dalla misura 46 alla 48 = XS
dalla misura 48 alla 50 = S
dalla misura 51 alla 53 = M
dalla misura 54 alla 56 = L
dalla misura 57 alla 59 = XL

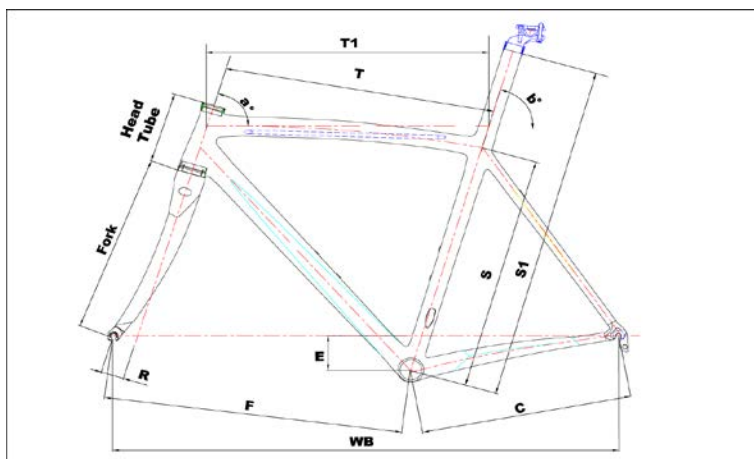

* REGGISELLA GHOST: REGOLAZIONE DA 40 A 50 mm OLTRE IL TUBO SELLA

* GHOST SEATPOST: ADJUSTABLE FROM 40 TO 50 mm UP TO SEAT TUBE LENGHT

SCATOLA MOVIMENTO / BB SHELL : PRESS FIT

BEST OF

Misura Size	Traditional size	S1	S	T1	T	Head Tube	a°	b°	R	C	F	WB	E	Fork
XS	490	635	440	520	509	119	71	74	45	406	576	971	73	368
S	510	660	465	530	520	136	72	74	45	406	579	974	73	368
M	530	680	485	545	534	150	73	73,5	45	408	580	977	71	368
L	550	695	500	560	548	174	73	73,5	45	408	596	994	71	368
XL	570	720	525	570	559	195	73	73	45	408	602	999	68	368

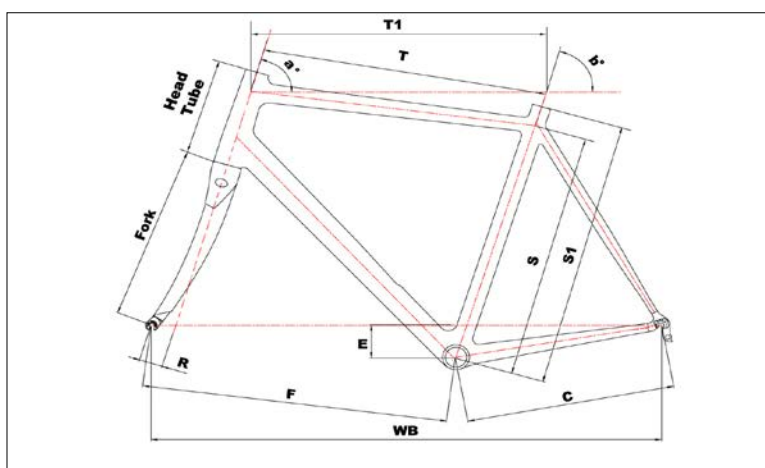

SCATOLA MOVIMENTO / BB SHELL : BB 30 (WITH BSA ADAPTOR)

STRATO

Misura Size	Traditional size	S1	S	T1	T	Head Tube	a°	b°	R	C	F	WB	E	Fork
XS	490	460	404	512	498	122	71,5°	75°	45	403	574	966	73	368
S	500	480	424	524	507	128	72°	74°	45	405	571	965	73	368
M	530	510	454	544	527	150	73°	73,5°	45	405	579	973	71	368
L	560	540	485	557	540	175	73,5°	73°	45	408	582	980	71	368
XL	590	570	515	579	561	205	73,5°	72,5°	45	408	599	997	68	368

GEOMETRIE TELAI CORSA ROAD FRAMES GEOMETRIES

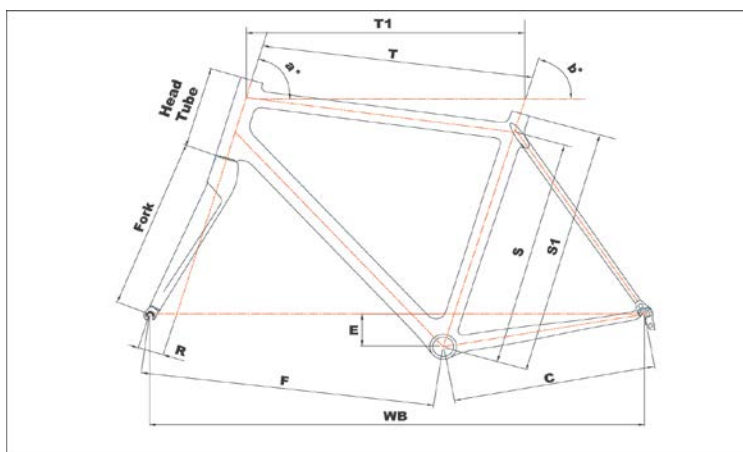

SCATOLA MOVIMENTO / BB SHELL : BB 30 (WITH BSA ADAPTOR)

ESTRADA

Misura Size	Traditional size	S1	S	T1	T	Head Tube	a°	b°	R	C	F	WB	E	Fork
XS	490	460	404	512	498,1	122	71,5	75	45	403	574	966	73	368
S	500	480	425	525	507,5	128	72	74	45	405	571	965	73	368
M	530	510	455	544,4	527,3	150	73	73,5	45	405	579	973	71	368
L	560	540	485	557,6	540,2	175	73,5	73	45	408	583	980	71	368
XL	590	570	515	579	562	205	73,5	72,5	45	408	600	998	68	368

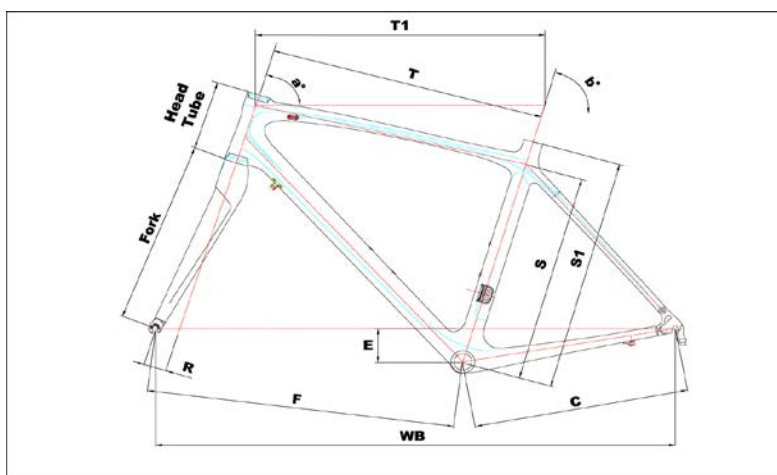

SCATOLA MOVIMENTO / BB SHELL : BSA

SAETTA SPRINT - SAETTA

Misura Size	Traditional size	S1	S	T1	T	Head Tube	a°	b°	R	C	F	WB	E	Fork
XS	480	430	370	512	493	120	71	74,5	45	404	572	965	73	368
S	490	440	380	525	505	130	72	74	45	406	573	969	70	368
M	520	480	420	545	524	145	72,5	73,5	45	406	584	981	68	368
L	540	520	460	550	531	165	73	73	45	408	586	984	68	368
XL	570	560	500	575	554	190	73,5	72,5	45	408	595	994	68	368

GEOMETRIE TELAI CORSA ROAD FRAMES GEOMETRIES

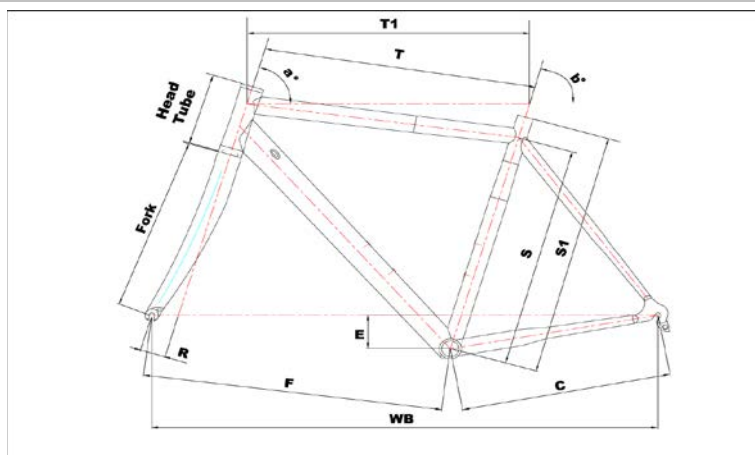

dalla misura 46 alla 48 = XS
dalla misura 48 alla 50 = S
dalla misura 51 alla 53 = M
dalla misura 54 alla 56 = L
dalla misura 57 alla 59 = XL

SCATOLA MOVIMENTO / BB SHELL: BSA

EXPERIENCE

Misura Size	Traditional size	S1	S	T1	T	Head Tube	a°	b°	R	C	F	WB	E	Fork
XS	490	460	375	522	502	125	72	74	45	407	569	964	73	368
S	500	480	435	527	510	125	72	74	45	407	573	969	73	368
M	530	510	465	545	530	150	73	73,5	45	407	581	977	71	368
L	560	540	495	560	544	173	73,5	73	45	407	585	981	71	368
XL	590	570	525	580	564	205	73,5	72,5	45	410	601	1001	68	368

GEOMETRIE TELAIO CICLOCROSS CYCLOCROSS FRAME GEOMETRIES

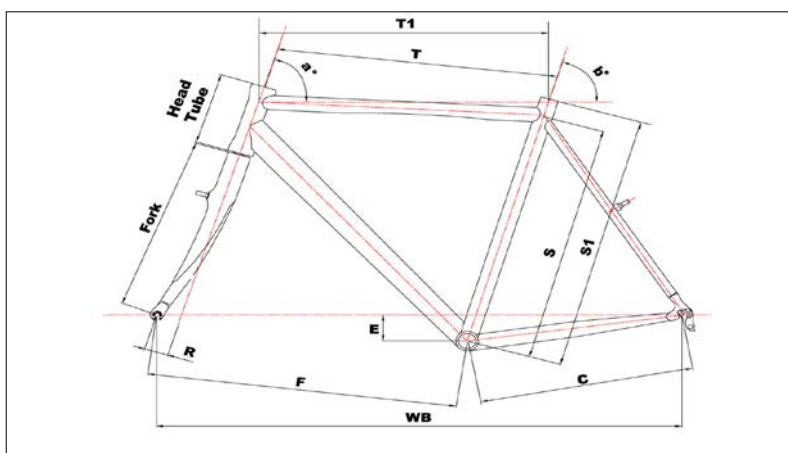

SCATOLA MOVIMENTO / BB SHELL: BSA

ZYDECO

Misura Size	Traditional size	S1	S	T1	T	Head Tube	a°	b°	R	C	F	WB	E	Fork
XS	520	511	473	520	515,5	110	71°	74,5°	45	425	585	1003	58	387,5
S	540	535	497	540	534	130	72°	74°	45	425	592	1010	58	387,5
M	560	562	524	560	553	155	72,5°	73,5°	45	425	603	1021	58	387,5
L	580	590	552	580	572	180	73°	73°	45	425	612	1030	58	387,5
XL	600	615	576	600	591	205	73°	73°	45	425	632	1050	58	387,5

GEOMETRIE TELAI CORSA ACCIAIO STEEL ROAD FRAMES GEOMETRIES

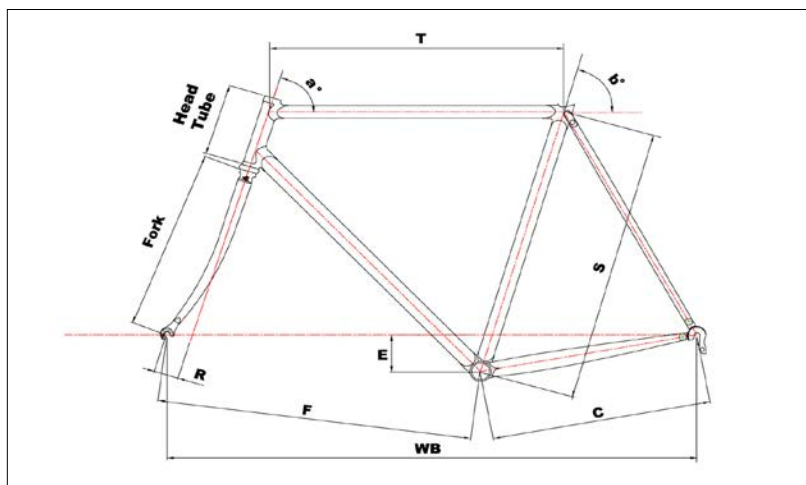

SCATOLA MOVIMENTO / BB SHELL : ITALIAN

SUPERCORSA

Misura Size	T	a°	b°	R	C	F	WB	E	Misura Size	T	a°	b°	R	C	F	WB	E
48	510	72	74,5	50	401	573	965	66	57	565	73	73,5	45	406	588	983	73
49	515	72	74,5	50	402	573	965	69	58	570	73	73	45	407	589	985	73
50	520	72,5	74,5	50	402	570	962	70	59	572	73	73	45	408	595	992	73
51	525	72,5	74	50	402	572	963	73	60	580	73	73	45	409	599	997	73
52	535	72,5	74	50	403	572	964	73	61	580	73	73	45	409	599	997	73
53	540	73	74	45	405	578	972	73	62	590	73	73	45	409	606	1004	73
54	545	73	73,5	45	405	578	972	73	63	590	73	73	45	410	606	1005	73
55	550	73	73,5	45	405	586	980	73	64	595	73	73	45	411	610	1010	73
56	560	73	73,5	45	405	587	981	73									

SCATOLA MOVIMENTO / BB SHELL : BSA

GAZZETTA DELLA STRADA

Misura Size	Tradizional size	S	T	Head Tube	a°	b°	R	C	F	WB	E	Fork
XS	500	500	520	100	72,5°	74,5°	45	402	572	963	73	375
S	520	520	535	102	72,5°	74°	45	403	572	964	73	375
M	540	540	545	122	73°	73,5°	45	405	579	973	73	375
L	560	560	555	142	73°	73,5°	45	405	589	983	73	375
XL	580	580	570	160	73°	73°	45	407	599	995	73	375
XXL	600	600	580	180	73°	73°	45	407	609	1005	73	375

GEOMETRIE TELAI CORSA ACCIAIO STEEL ROAD FRAMES GEOMETRIES

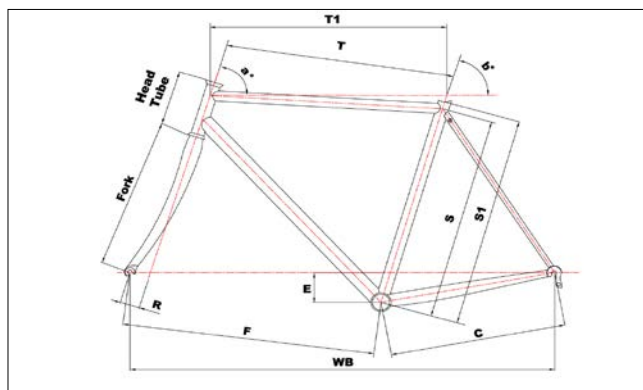

SCATOLA MOVIMETO / BB SHELL : BSA

XCr

Misura Size	Traditional size	S1	S	T1	T	Head Tube	a°	b°	R	C	F	WB	E	Fork
XS	480	460	415	515	502	119	71,5	74,5	45	403	570	963	73	368
S	500	480	435	525	510	125	72	74	45	405	571	965	73	368
M	530	510	465	545	530	142	73	73,5	45	405	579	973	71	368
L	560	540	495	558	544	160	73,5	73	45	408	583	980	71	368
XL	590	570	525	579	564	190	73,5	72,5	45	408	600	998	68	368

GEOMETRIE TELAI PISTA TRACK FRAMES GEOMETRIES

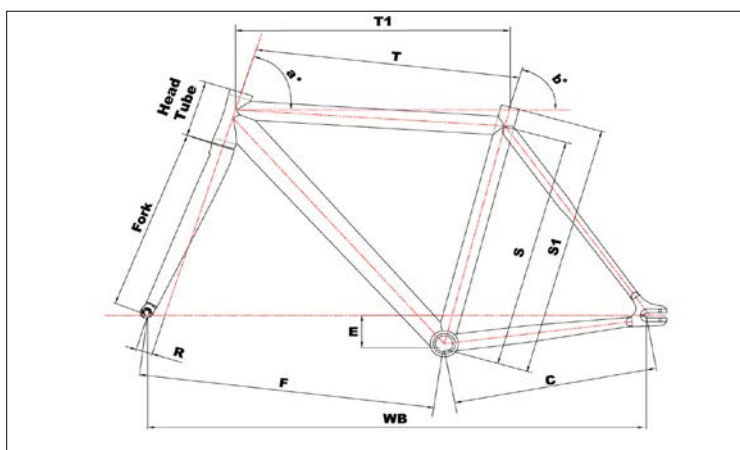

SCATOLA MOVIMENTO / BB SHELL : BSA

VIGORELLI

Misura Size	S1	S	T1	T	Head Tube	a°	b°	R	C	F	WB	E	Fork	Slope
500	500	460	520	513	114	72,5	75,5	35	389	570	952	58	366	39,5
520	520	480	535	526	134	72,5	75	35	390	582	965	58	366	40,0
540	540	500	545	537	150	73	74,5	35	392	582	966	58	366	40,0
560	560	520	555	546	170	73	74,5	35	392	592	977	58	366	39,5
580	580	540	575	565	188	73	73,5	35	395	602	990	58	366	40,0

* VIGORELLI: BATTUTA MOZZO POSTERIORE 120mm / REAR HUB DIMENSION 120mm

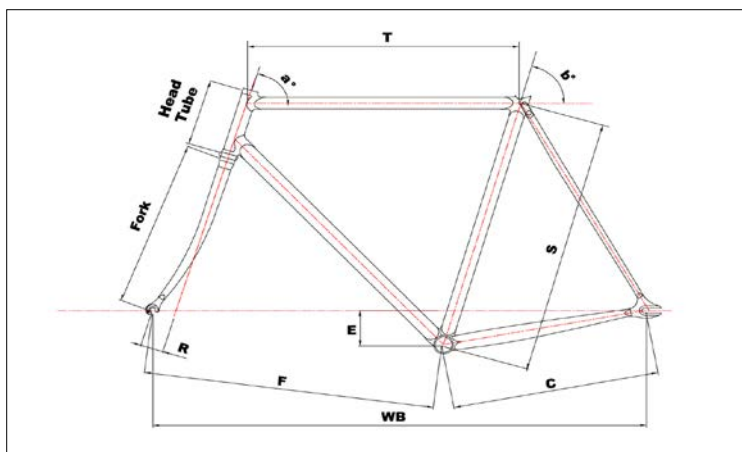

SCATOLA MOVIMENTO / BB SHELL : ITALIAN

SUPERCORSA PISTA

Misura Size	T	a°	b°	R	C	F	WB	E
49	520	72	75	35	388	567	946	60
50	520	73	75	35	388	567	946	60
51	525	73	75	35	388	568	948	60
52	535	73	75	35	388	569	949	60
53	540	73	75	35	388	571	951	60
54	545	74	75	35	388	572	952	60
55	550	74	75	35	388	575	955	60
56	555	74,5	74,5	35	388	578	958	60
57	560	74,5	74	35	390	580	962	60
58	565	74,5	74	35	390	585	967	60
59	570	75	74	35	390	583	965	60
60	575	75	74	35	390	586	968	60
61	580	75	74	35	390	592	974	60

GEOMETRIE TELAI PISTA TRACK FRAMES GEOMETRIES

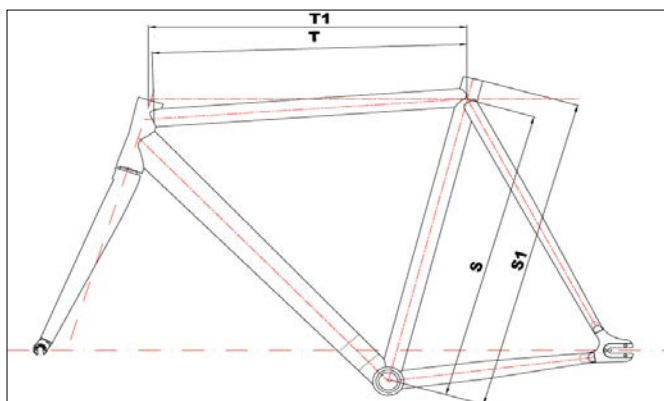

SCATOLA MOVIMENTO / BB SHELL : BSA

MASH

Misura Size	Traditional size	S1	S	T1	T
XS	48	520	480	505	508
S	500	540	500	517	520
M	530	570	530	530	544
L	550	590	550	550	563
XL	580	620	580	575	590

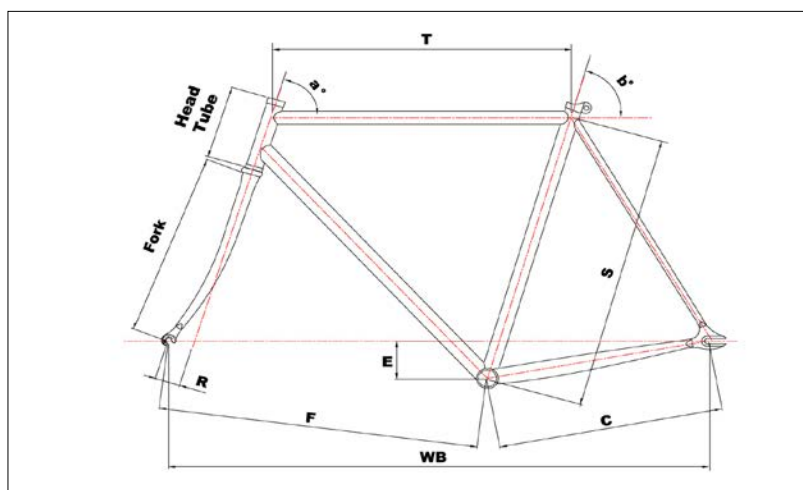

SCATOLA MOVIMENTO / BB SHELL : BSA

GAZZETTA

Misura Size	Traditional size	S	T	Head Tube	a°	b°	R	C	F	WB	E	Fork
XS	500	500	520	100	73°	75°	35	385	560	939	58	368
S	520	520	535	115	73°	75°	45	385	568	949	58	368
M	540	540	545	144	74,5°	75°	35	385	573	951	58	368
L	560	560	555	160	74,5°	74,5°	35	385	578	957	58	368
XL	580	580	565	175	74,5°	74°	35	385	583	962	58	368
XXL	600	600	575	190	75°	74°	35	385	587	962	58	368

GEOMETRIE TELAI BOOTLEG BOOTLEG FRAMES GEOMETRIES

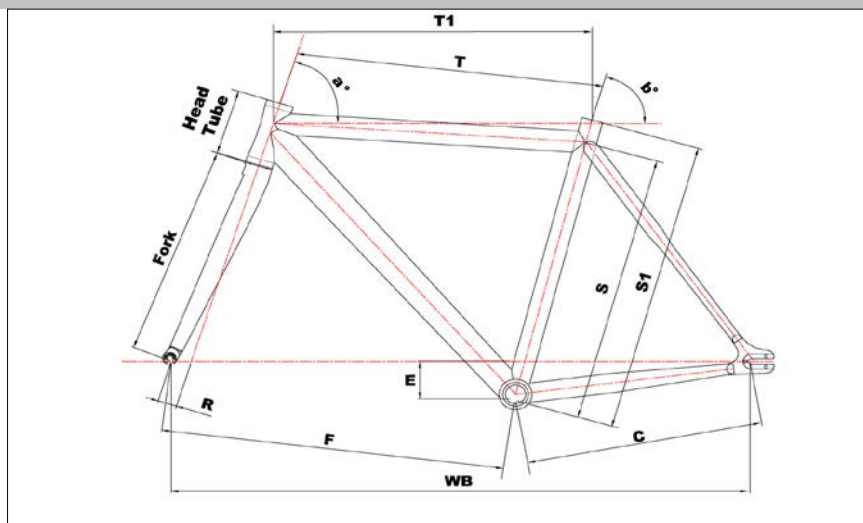

SCATOLA MOVIMENTO / BB SHELL: BSA

MYSTIC RATS

Misura Size	S1	S	T1	T	Head Tube	a°	b°	R	C	F	WB	E	Fork
XS	470	430	515	505	112	71,5	75,5	35	389	569	951	58	366
S	500	460	520	512	114	72,5	75,5	35	389	570	952	58	366
M	520	480	535	526	134	72,5	75	35	390	582	965	58	366
L	540	500	545	536	150	73°	74,5	35	392	582	966	58	366
XL	560	520	555	546	170	73,0	74,5	35	392	592	977	58	366
XXL	580	540	575	565	188	73,0	73,5	35	395	602	990	58	366

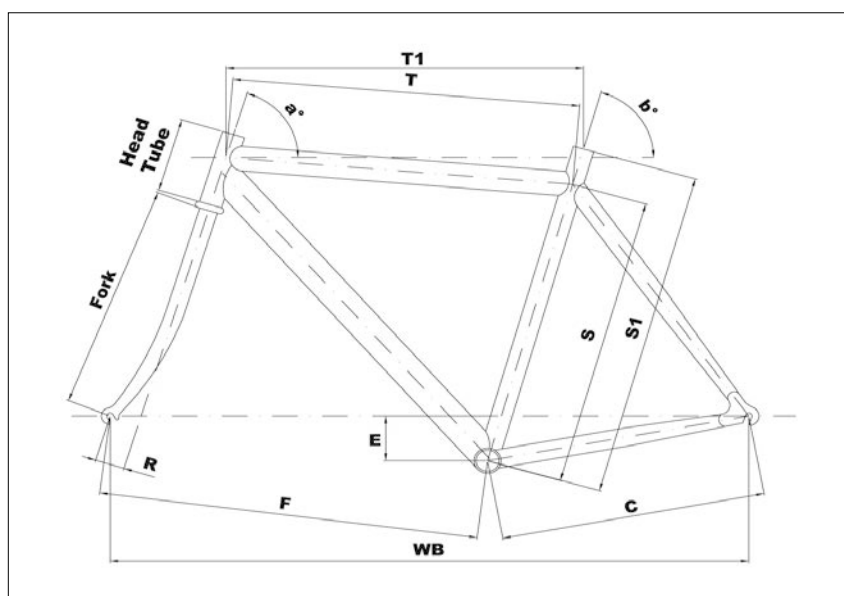

SCATOLA MOVIMENTO / BB SHELL: BSA

HOY HOY RATS - RACING RATS

Misura Size	S1	S	T1	T	Head Tube	a°	b°	R	C	F	WB	E	Fork
S	460	415	532	513	130	72	74,5	45	425	586	1001	70	387,5
M	490	445	552	532	145	73	74	45	425	592	1007	70	387,5
L	520	475	570	549	165	73	73	45	425	600	1016	68	387,5
XL	540	496	585	558	180	73	72,5	45	425	609	1025	68	387,5

ACCESSORI DI SERIE FORNITI CON KIT TELAI
COMPONENTS SUPPLIED WITH FRAME KITS
STRADA E PISTA / ROAD & TRACK

MODELLO MODEL	FORCELLA FORK	ATTACCO STEM	CURVA HANDLEBAR	NASTRO TAPE	SERIE STERZO HEAD SET	REGGISILLA SEAT POST	ATTACCO DERAGLIATORE FRONT DERAILLEUR ADAPTOR
BEST OF	COLUMBUS Genius	CINELLI RAM 2 Bianca / RAM 2Tricolor		CINELLI Gel	COLUMBUS Oversize 1 1/8" - 1 1/2"	COLUMBUS Ghost Ø 31,6	Fascetta Clamp
STRATO	COLUMBUS Genius	CINELLI RAM 2 Bianca / RAM 2 Strato		CINELLI Gel	COLUMBUS Oversize 1 1/8" - 1 1/2"	CINELLI Ram Bianca / Ram Strato Ø 31,6	A saldare Braze on
ESTRADA	COLUMBUS SOLIDA monocoque 1"-1/8"	CINELLI Graphis Bianca Ø 31,8	CINELLI Ram Bar Bianca Ø 31,8	CINELLI Cork	COLUMBUS N°8b Plus Ø 45	CINELLI Graphis Bianca Ø 31,6	Fascetta Clamp
SAETTA SPRINT	COLUMBUS SOLIDA monocoque 1"-1/8"	CINELLI Graphis Ø 31,8	CINELLI Graphis Compact Ø 31,8	CINELLI Gel	COLUMBUS N°8b Ø 45	CINELLI Graphis Ø 31,6	A saldare Braze on
SAETTA	CINELLI SAETTA 1"-1/8"	CINELLI Vai / Vai Bianca Ø 31,8	CINELLI Vai Compact / Bianca Ø 31,8	CINELLI Cork	COLUMBUS N°8b Ø 45	CINELLI Vai / Vai Bianca Ø 31,6	A saldare Braze on
EXPERIENCE	CINELLI SAETTA 1"-1/8"	CINELLI Vai / Vai Bianca Ø 31,8	CINELLI Vai Compact / Bianca Ø 31,8	CINELLI Cork	COLUMBUS N°8b Ø 45	CINELLI Vai / Vai Bianca Ø 27,2	Fascetta Clamp
ZYDECO	COLUMBUS Tusk Cross 1"-1/8"	CINELLI Lux Ø 31,8	CINELLI Lux Ø 31,8	CINELLI Bubble	FSA No. 9 CX Ø 50mm	CINELLI Lux Ø 31,6	Fascetta Clamp
GAZZETTA DELLA STRADA	COLUMBUS Cr-Mo Steel 1"-1/8"	-----	-----	-----	-----	-----	A saldare Braze on
VIGORELLI	COLUMBUS Carbon 1"-1/8" Aluminium steerer	CINELLI Pista Ø 31,8	CINELLI Pista Alu Ø 31,8	CINELLI Cork	COLUMBUS N°8b Ø 45	CINELLI Vai Ø 31,6	-----
XCr	COLUMBUS Minimal carbon monocoque 1-1/8"	-----	-----	-----	-----	-----	Fascetta Ø 33 Clamp Ø 33
SUPERCORSA	COLUMBUS Neuron Steel 1"filettata-threaded	-----	-----	-----	-----	-----	A saldare Braze on
SUPERCORSA PISTA	COLUMBUS Keirin Steel 1"filettata-threaded	-----	-----	-----	-----	-----	-----
MASH	COLUMBUS Carbon 1-1/8" Aluminium steerer	-----	-----	-----	COLUMBUS N°8b Ø 45	-----	-----
GAZZETTA	COLUMBUS Cr-Mo Steel 1"-1/8"	-----	-----	-----	-----	-----	-----

MISURA TELAIO FRAME SIZE	ATTACCO (mm) STEM (mm)	CURVA C.C. (cm) HANDLEBAR C.C. (cm)	RAM 2
XS	100	40	40 / 100
S	100	40	40 / 100
M	110	42	42 / 110
L	120	42	42 / 120
XL	120	42	42 / 130
XXL	120	44	44 / 130

BOOTLEG

MODELLO MODEL	FORCELLA FORK	ATTACCO STEM	CURVA HANDLEBAR	NASTRO TAPE	SERIE STERZO HEAD SET	REGGISILLA SEAT POST	GUARNITURA CRANK SET
DOS RATS	-----	Ant./Front CINELLI VaiØ31,8 Post.regolabile / Rear adj	Rialzata/Raised 25mm DB 6061 Aluminium alloy	-----	-----	Ø 27,2mm	FSA Gossamer Tandem+Eccentrico